

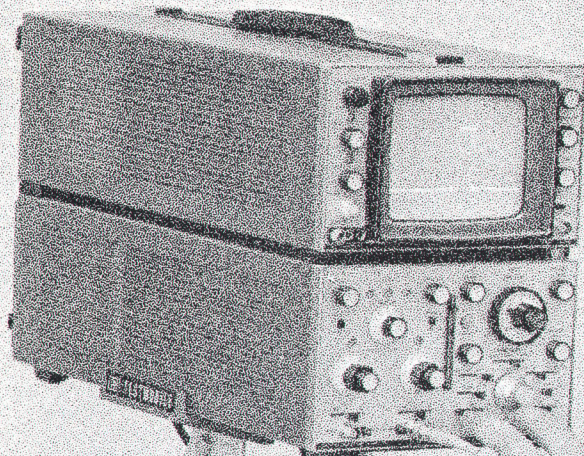

HEWLETT-PACKARD JOURNAL

TECHNICAL INFORMATION FROM THE -hp- LABORATORIES

CORPORATE OFFICES • 1501 PAGE MILL ROAD • PALO ALTO, CALIFORNIA 94304 • VOL. 17, NO. 12 AUGUST 1966



COVER: TRANSISTORIZED >50 -MHz OSCILLOSCOPE
ADAPTED TO THE FUTURE, p. 2

SEE ALSO: 1966 FLYING CLOCKS, p. 13
CESIUM-BEAM RESONATORS, p. 17
-hp- FREQUENCY STANDARD, p. 20



The complete -hp- Model 180A Oscilloscope system includes plug-ins, a new scope cart, new probes, viewing hoods, camera adapters and the -hp- Model 197A Oscilloscope Camera. Both the cabinet and rack mount versions of the oscilloscope are shown here.

A NEW DC-50⁺ MHz TRANSISTORIZED OSCILLOSCOPE OF BASIC INSTRUMENTATION CHARACTER

A small-size portable oscilloscope with negligible trace drift and using plug-ins has been designed as the keystone of a complete oscilloscope system.

COMPLEX WAVEFORMS encountered in computer systems, of the type shown in Fig. 1, are difficult to see on all but the most sophisticated, high-frequency oscilloscopes. These instruments have been large and usually heavy and awkward to handle. They are not suited for work in limited space often found in and around computers, especially shipboard and aircraft installations.

While solid-state devices have reduced the size and weight of high frequency oscilloscopes, the goal of a completely solid-state, lightweight, high-frequency laboratory oscilloscope has not been achieved because of the lack of suitable cathode-ray tubes and tran-

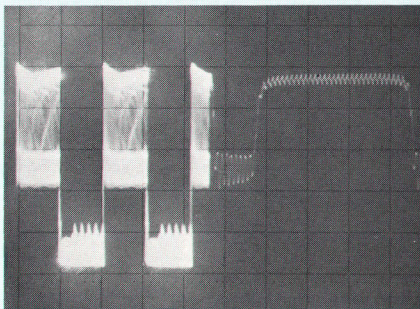
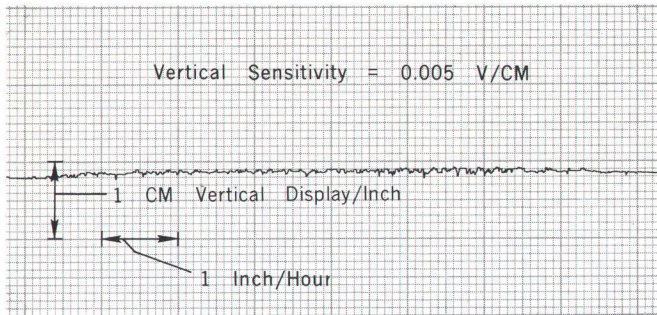

Fig. 1. Pulse trains of the type shown here are comparable in complexity to those found in computer circuitry. These are 100-kHz pulses with 50 MHz riding on top. Using the mixed delay feature of the -hp- Model 180A Oscilloscope, the waveform (right half of photo) is expanded 250 times.

sistors. Cathode-ray tubes used in current high-frequency oscilloscopes provide adequate electrical performance, but are not suitable for compact general-purpose oscilloscopes because of their length or lack of sensitivity.

Until recently, solid-state devices adequate for use in input stages and as CRT drivers in low power drain circuits have not been available. Present delay line designs are too large or too heavy to fit into a small space.

Now, a new, portable 50-MHz oscilloscope has been designed which combines all of the latest technical advances into a sophisticated, laboratory type instrument, Fig. 3. The oscillo-



(a)

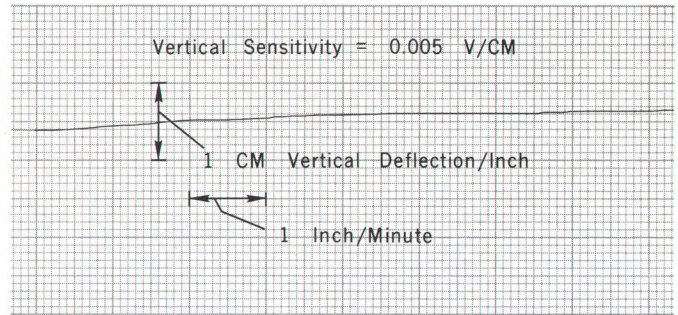

(b)

Fig. 2. All-solid-state design results in excellent stability. With the input dc coupled, the oscilloscope maintains stability over a 9-hour period of less than 0.1 cm. (a) After cold turn-on, the oscilloscope stabilizes in about 8 minutes (b).

scope is all solid state except for the CRT. Although lightweight and compact, the scope has performance characteristics equal to or surpassing those of the larger conventional high-frequency oscilloscopes. A short cathode-ray tube with an 8 x 10 cm viewing screen, about double the screen area of current portable oscilloscopes, is an important feature. High writing rate, outstanding triggering capability, nearly instant turn-on with very low drift are among the other noteworthy accomplishments.

The all solid-state circuitry reduces power dissipation thus eliminating the need for a cooling fan. This not only reduces the weight of the instrument but also allows operation at power line frequencies from 50 to 1000 Hz.

Maximum flexibility and protection against obsolescence is provided by the use of dual plug-ins. Only the CRT beam controls and the horizontal amplifier and power supplies are built into the main frame. Performance of the oscilloscope is limited only by the performance limitations of the CRT and horizontal amplifier. These limits are well beyond the specified 50-MHz bandwidth of the scope, so that the bandwidth of the scope may be extended as upgraded plug-ins become available.

Among the accessories that make up a complete oscilloscope system are a new scope cart, viewing hoods, new probes and a newly designed oscilloscope camera. Three plug-ins are presently available—one vertical unit and two horizontal sweep plug-ins.

TRIGGERING CAPABILITY

Exceptional triggering performance of the oscilloscope is realized because the vertical amplifiers are designed to get a faithful, stable vertical signal into the horizontal sweep circuit. Fig. 4(a) shows a 100-MHz sine wave locked us-

ing external sync. Internal sync capability is demonstrated in Fig. 4(b) with a 70-MHz signal at about 7-mV input. Triggering specifications depend upon the combination of output characteristics of the sync amplifier of the vertical plug-in, and the trigger sensitivity of the horizontal system.

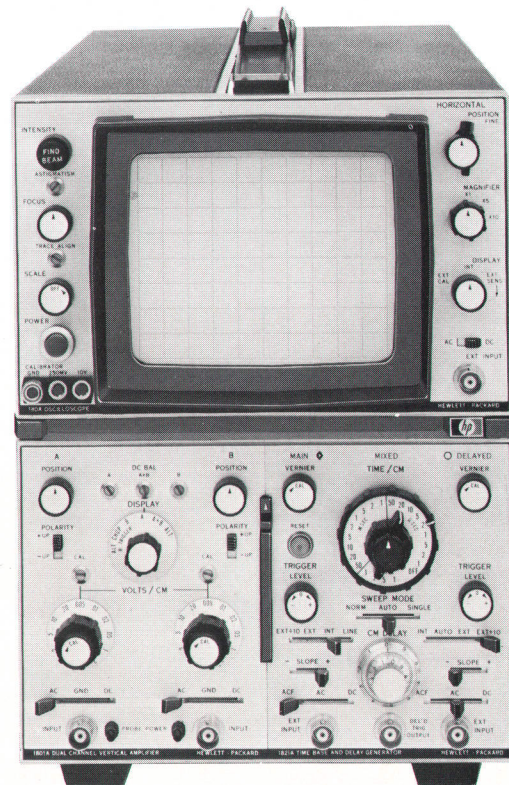
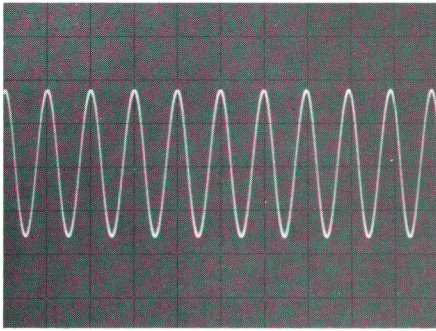
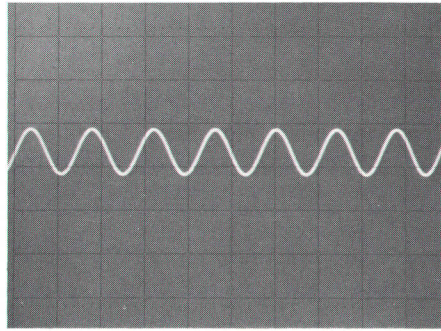

Fig. 3. The front panel of the oscilloscope, shown here $\frac{3}{8}$ actual size, is slightly shorter than this page height and slightly narrower than this page width. Controls are clearly marked and arranged so they are not obscured by cables. Plug-ins are in the lower half of this cabinet version, with CRT beam controls and horizontal amplifier controls in the upper half.



(a)



(b)

Fig. 4. Using external sync, a 100-MHz sine wave is displayed (a). With internal triggering, a 70-MHz sine wave (b) may be locked in, showing exceptional triggering capability.

VERTICAL STABILITY

Solid-state components used in the vertical system have resulted in a great improvement in stability and reliability. A reduction in heat generated within the instrument and the use of low temperature coefficient components provide unusual long term stability, Fig. 2(a). The time required to stabilize after cold turn-on is only about 8 minutes, as shown in Fig. 2(b).

VERTICAL PLUG-IN

Design of the vertical amplifiers was aimed at providing excellent stability and reliability with nearly instant turn-on, while maintaining full bandwidth at each attenuator position without

trace jump. A good internal trigger to the horizontal amplifier had to be maintained.

The key to the attenuator design has been the careful placing of components. Each twelve-step attenuator consists of two sections using a combination of decades rather than 12 discrete steps. Components are saved and construction is simplified.

Since the attenuator is at the amplifier input, Fig. 5, the amplifier has been designed with constant gain. Trace jump caused by switching ranges using interstage attenuation is eliminated. All of the amplifier specifications are the same regardless of the sensitivity setting. Maximum sensitivity is 0.005

V/cm.

Vernier and calibration controls are placed in the middle of a cascode amplifier. Thus they control signal current instead of signal voltage and do not affect feedback capacity, thereby minimizing changes in vertical amplifier response.

Field effect transistors at the amplifier inputs give high impedance, good bandwidth and provide the quick turn-on capability. By replacing nuvistors with FET's, a total of about 2½ watts of power was saved. Differential pairs are mounted on the same heat sink to keep them in the same thermal environment. In some places, dual transistors are used to get good tracking. For

SHORT, LARGE SCREEN, HIGH-FREQUENCY CRT

Fitting a cathode ray tube into a portable 50-MHz oscilloscope presents both electrical and mechanical problems. Needed was a relatively short tube with a large screen, with sufficient brightness at the high writing rates encountered in high-frequency scopes, a small spot size, with a deflection factor low enough to be driven with solid-state circuitry.

The search for a short tube with all these characteristics resulted in the development of a version of the radial-field mesh tube. In the radial-field mesh tube,¹ a spherical, high transmission mesh is placed so its center of curvature in relation to the deflection plates is such that there is a force acting on the beam to magnify or expand the display. Display magnifications of up to 20% horizontally and 10 to 40% vertically are typical. However, the conventional radial-field mesh tube must be relatively long for proper performance.

The new CRT is also a mesh tube, but

the helix is eliminated, and the mesh is not spherical but more highly contoured to provide a higher degree of magnification of the display. The mesh contour is designed to provide proper linearity characteristics of the display.

Along with the large screen display in the short tube, a modest improvement in spot size and writing speed was obtained. Vertical deflection factor is about equal to that of the conventional radial-field

tube and the horizontal deflection factor has been improved by about 25%.

Screen size of the CRT is 8 x 10 cm, with a length of 17 inches, accelerating voltage is 12 kV, vertical deflection factor is 3 V/cm, horizontal deflection factor is 9 V/cm. Spot size at 200 foot-lamberts brightness is typically 14 mils at the center and edge. Horizontal sensitivity is maintained over a bandwidth higher than 150 MHz.

An auxiliary tungsten filament cathode, called a flood gun, is used to provide a low level of background illumination so that graticule lines are visible in photographs and in low ambient light situations. A positive voltage is applied to the mesh causing electrons to be drawn to it from the flood gun. Some of the electrons pass through the mesh and are accelerated to the phosphor screen providing uniform background lighting. This eliminates the need for multiple exposures when taking photographs. Intensity of the background light is controlled by adjusting the temperature of the flood gun filament.

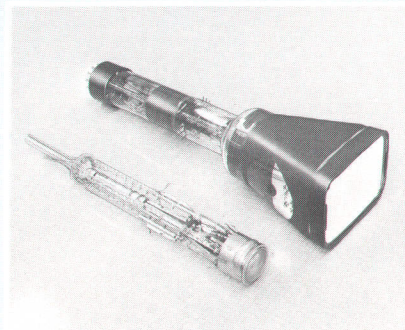

¹ 'The Radial Field Cathode-Ray Tube,' 'Hewlett-Packard Journal,' Vol. 15, No. 1, Sept., 1963.

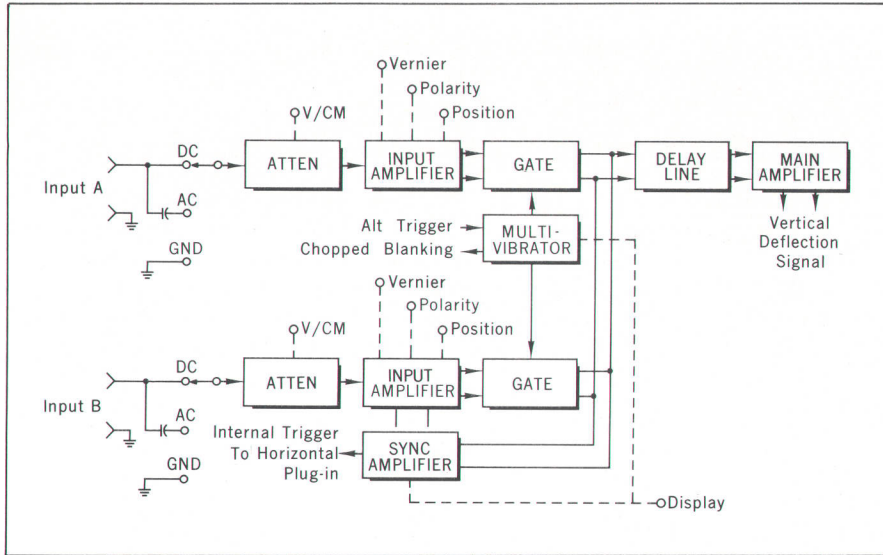

Fig. 5. Input amplifiers in the dual-channel vertical plug-in use field effect transistors and inputs are balanced. Attenuators are at the amplifier inputs to eliminate trace jump when switching ranges. Vertical amplifier controls are shown in this block diagram.

the highest reliability, the design uses all silicon devices except for one germanium diode needed for saturation protection. All of the passive components are premium quality with low temperature coefficient.

DC SWITCHING

Long shafts to switches and long leads were eliminated by going to dc switching of signals in the vertical am-

plifier. Signals are brought directly to the point where they are needed, then switching is performed by turning diodes on and off. An example is shown in the simplified schematic of polarity switching, Fig. 6. Every front panel function except sensitivity and calibration is accomplished in this way, thereby reducing interference and making the plug-in more accessible for service.

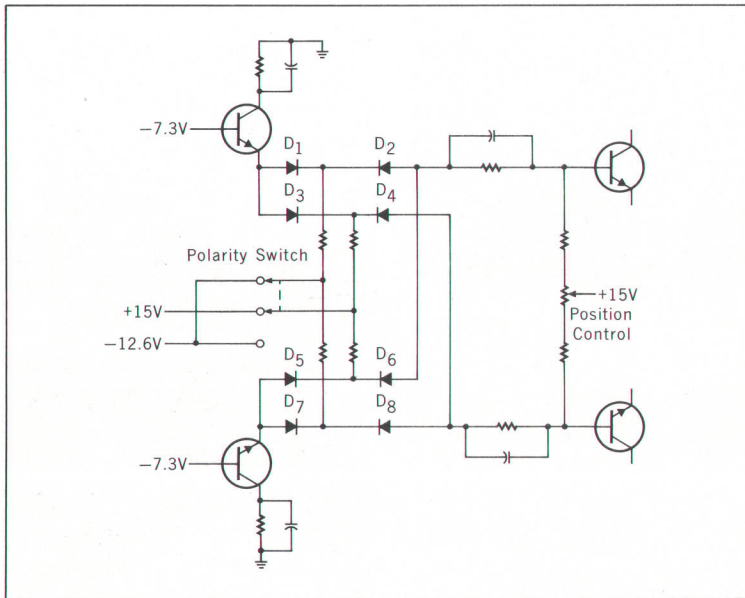

Fig. 6. Polarity of the input to the vertical amplifiers is switched by switching diode gates. In the 'up' or + position, diodes D_3 , D_4 , D_7 and D_8 are turned on while D_1 , D_2 , D_5 and D_6 are reversed biased. The signal path is across D_1 , D_2 , and D_7 , D_8 . Reversing polarity reverses the bias.

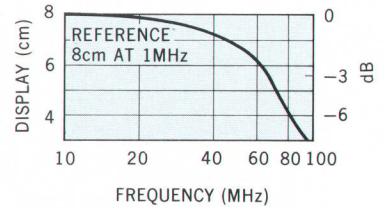

Fig. 7. Typical bandwidth plot of the -hp- Model 1801 Dual Channel Vertical Amplifier. Deflection factor is 5 mV/cm over the specified bandwidth.

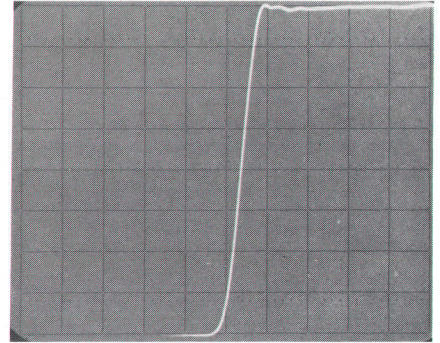

Fig. 8. A pulse with less than 7 ns rise time illustrates the bandwidth capabilities of the scope.

One factor in assuring good sync is a type of balun amplifier circuit at the output of the sync amplifier which converts the differential output to a single-ended output. Previous methods of making this conversion resulted in cutting amplifier gain about in half. The method used here makes the conversion without loss of gain, and with stable dc operation at the full bandwidth of the amplifier.

Bandwidth of the vertical amplifiers, Fig. 7, is dc to above 50 MHz, direct-coupled and 2 Hz to above 50 MHz ac coupled. Rise time is less than 7 ns, Fig. 8.

HORIZONTAL SWEEP PLUG-IN

Two horizontal plug-ins have been designed for the new oscilloscope initially. One is a sweep delay unit covering a main sweep range from 0.1 μ s/cm to 1 s/cm, shown at the right in Fig. 9. The other unit is a simplified version containing only one sweep generator, but covering a wider range from 0.05 μ s/cm to 2 s/cm.

In the sweep delay plug-in, the main sweep is also the delaying sweep. The delayed time base sweeps after the delay is set by the main sweep and delay controls. In a delayed sweep system, it



Fig. 9. Controls on the plug-ins are grouped according to function. Vertical amplifiers are in the plug-in at the left and channel controls are arranged vertically with the display control in the center. The horizontal sweep plug-in at the right includes sweep delay.

is not consistent to have the delayed sweep run slower than the delaying sweep, since the purpose of the system is to magnify a waveform. Therefore, a mechanical interlock on the sweep switch is provided so that this situation cannot exist. Delayed sweep ranges from $0.1 \mu\text{s}/\text{cm}$ to $50 \text{ ms}/\text{cm}$ in a 1, 2, 5 sequence. With the vernier, the slowest delayed sweep may be extended to about $125 \text{ ms}/\text{cm}$. An example of mixed delaying and delayed sweep is shown in Fig. 10.

AUTOMATIC SWEEP

An automatic sweep mode is included in the horizontal sweep plug-in which displays a base line in the absence of an input signal. With no input signal, a free-running trace occurs and the base line position is always known. An input signal triggers the sweep automatically, and triggering can be chosen to occur at any level on a waveform.

VARIABLE HOLD-OFF

Generally, pulse trains not related in time to any particular sweep rate appear on most oscilloscopes as double triggering. This is because a conventional sweep circuit will synchronize on the first signal that occurs after the hold-off period. The first signal, however, is not necessarily the first pulse of a train.

A new feature called a variable trigger hold-off has been incorporated into the simplified version of the horizontal sweep plug-in. The sweep repetition rate is variable, allowing positive sync on the first pulse of any train. Hold-off between sweeps can be increased to a longer period than the normal free-

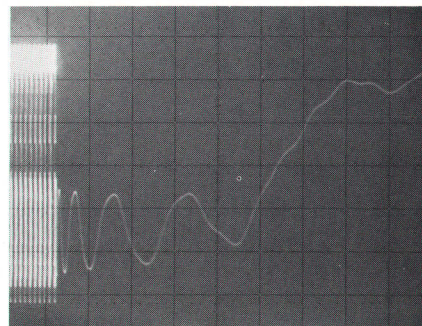

(a)

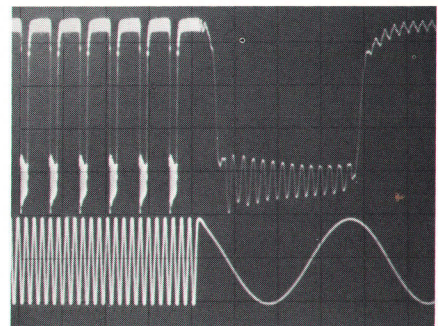

(b)

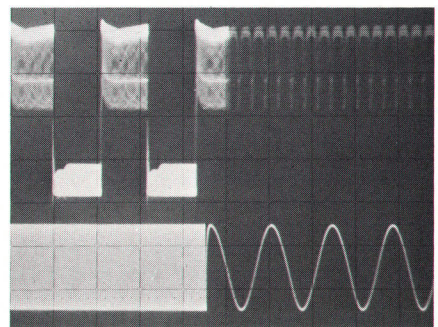

(c)

Fig. 10. Using the mixed delay feature of the horizontal plug-in enables the viewing of details of 100-kHz pulses. In (a), the delayed sweep is set to give a 1000 to 1 expansion of the waveform. Two waveforms may be displayed using the alternate mode. In (b), the lower signal is 1.2 MHz and in (c) the lower signal is 425 kHz. In both oscillograms, the trace at the right is expanded 20 times.

running period, thus making it possible to trigger on periodic waveforms that may be complex and with periods different than the scope period.

HORIZONTAL AMPLIFIER

Although the CRT sensitivity is such that it can be driven by a single-transistor Class A output stage, the method requires a great deal of power. A standard Class A circuit in this application would need resistors rated about 5 to 7 watts, and a high voltage power supply.

With the availability of fast NPN and PNP complementary transistors capable of collector-to-emitter voltages of 100 volts, it was possible to design an essentially Class B circuit that is faster and of much higher efficiency. Although the circuit requires more components and is more complex, a savings in weight and size is achieved by eliminating the high-voltage power supply and the large resistors, and reducing overall power consumption of the scope.

The use of a complementary transistor output stage in the horizontal amplifier permits it to operate from a relatively low supply voltage and give linear operation. The load is a com-

COMPACT, WIDEBAND, STRIPLINE DELAY LINE

In oscilloscopes with about 10 MHz capability and above, it is necessary to delay the signal being observed before it is fed to the CRT vertical plates. This is so that the part of the signal that triggers the sweep will be seen on the display. Delay values are generally about 150 to 200 ns.

In this scope, the delay line must fit into a relatively small plug-in. Small helically-wound delay lines are possible, but their bandwidth is limited. Cable delay lines are difficult to make in small packages. The solution to this problem was a differential stripline, laid down on both sides of a copper-clad Teflon-glass substrate as shown in the sketch. The line is 2 inches wide and 36.85 inches long and is rolled up. Delay is 160 ns, bandwidth is about 140 MHz, risetime is 2.5 ns and the line's characteristic impedance is 90 ohms and is held constant along the line for clean pulse response. Weighing only 16 ounces, the finished line fits into a space $6\frac{3}{4} \times 1\frac{1}{4} \times 1\frac{3}{8}$ inches.

Operation of the delay line can be explained by the manner in which the fields interact because of alternating crossovers of opposing conductors as shown in the sketch. Currents in the two conductors flow in the same direction except for a

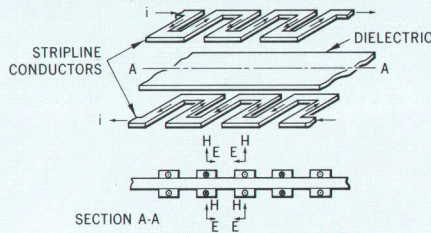

very short distance where the conductor turns around. The electric fields cancel because each conductor doubles back on itself. The magnetic fields add. When the conductors are very close, the total effect is the same as increasing the inductance of the line by a factor of four. Characteristic impedance is determined by the dimensions of the conductors, the distance between them and the thickness and character of the dielectric. Constants chosen here resulted in a Z_0 of 90 ohms, a value for which current and power requirements are minimized, yet impedance is not so high that unwanted capacitance damages the line's performance.

For a single-ended strip delay line, time delay T_D is calculated from the formula

$$T_D = s \sqrt{\epsilon_r} \text{ ns/ft}$$

where s is the distance an electromag-

netic wave travels in 1 nanosecond in a metallic conductor with permeability and dielectric constant equal to 1 (about 1 foot), and ϵ_r is the dielectric constant of the substrate material.

For a differential delay line of the type designed for this application, the formula is multiplied by a factor k , a function of the coupling between the conductors, and ϵ_r is the dielectric constant of the material separating the conductors. Then

$$T_D = ks \sqrt{\epsilon_r} \text{ ns/ft}$$

If k can be made greater than unity, the length of the line can be reduced. The coupling coefficient k actually achieved in this delay line is about 1.95. Total conductor length for 160 ns delay is about 51.2 feet.

Time domain reflectometry was used extensively during design, and is used to determine performance of finished units and to detect faults. The exact location and nature of faults within the rolled-up differential delay lines can be revealed with TDR. Reflections are held to less than 1%.

Besides resulting in a compact delay line, this design achieves a higher rise time in comparison with conventional units along with a high degree of uniformity in production.

plementary transistor, Fig. 11, biased at a low dc current to supply current to the feedback loop around the operational amplifier and provide low frequency operation. A clamp circuit working in conjunction with the feedback loop keeps the output amplifier operating in its linear region.

Another feedback connection, Z'_{fb} , between the CRT deflection plates helps maintain the average voltage on the plates. Changes in the voltage relationship between plates will change sensitivity and affect accuracy.

In the block diagram, each differential amplifier feeds the input of an operational amplifier. For slow sweeps (low frequency signals), the operational amplifiers act normally and drive the CRT deflection plates. As the input dV/dt increases, C_1 and C_2 couple increasing signals to the complementary load transistors Q_1 and Q_4 . While Q_2 is driven harder to provide more cur-

rent to discharge the plate capacity, Q_4 is driven harder to provide more current to the plates. During flyback, the process is reversed with Q_3 and Q_1 driven harder while current through Q_2 and Q_4 decreases.

During the $\times 10$ expansion, the duty

cycle is very low, thus average power consumption from the power supply is low. Also at the $\times 10$ expansion, the circuit readily delivers a linear sweep speed of 5 ns/cm. This sweep speed is twice that previously attained. Its value, of course, lies in the resolution

Fig. 11. Complementary PNP and NPN transistors in the horizontal amplifier circuit are fast with a high breakdown voltage. The circuit has high linearity, low power consumption and provides a high impedance source for driving the deflection plates.

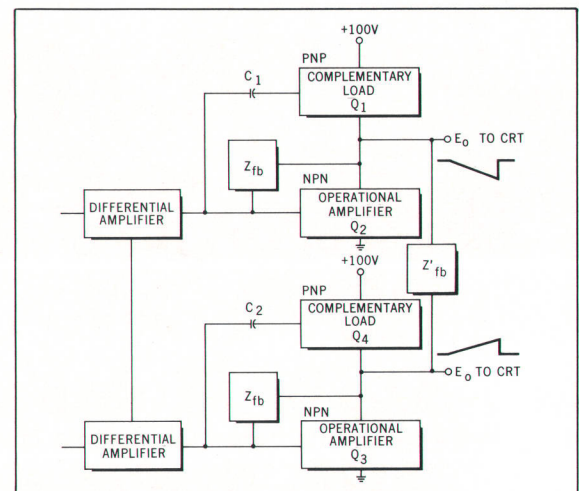

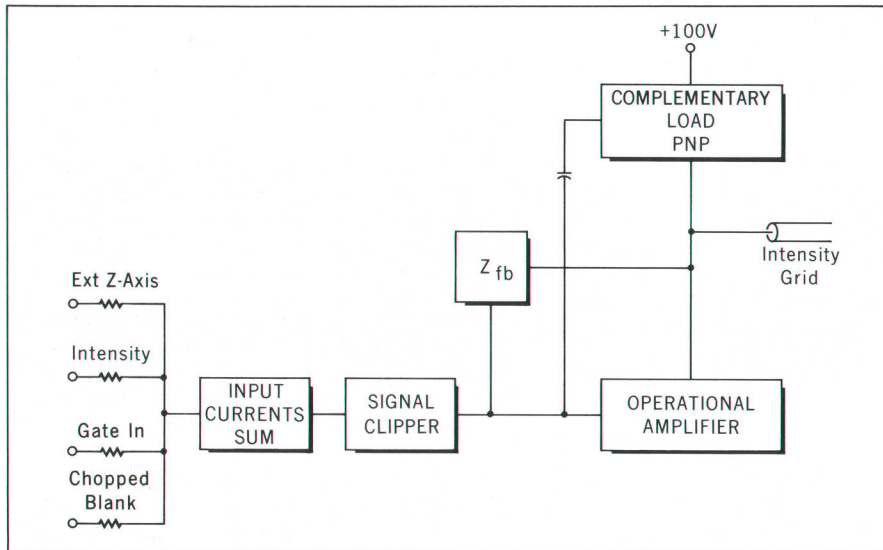

Fig. 12. Various inputs to the gate amplifier are converted to currents and added in a common-base amplifier.

with which nanosecond risetime pulses may be analyzed.

GATE AMPLIFIER

For easier handling of the various input signals applied to the z-axis circuits of the oscilloscope, the designers chose to convert voltage signals, including intensity, chopped blanking and external inputs, into currents. These input currents are then added, Fig. 12, in a common-base amplifier. Two advantages of this method are immediately obvious: first, there are no large voltage swings on the cabling within the scope, and second, the signal cables operate at lower impedance

levels — about 50 to 100 ohms.

Since the input must accept signals of a greater dynamic range than the output can handle, there is a danger of overdriving. An amplitude limiting or 'clipper' circuit follows the input summer which maintains the same input pulse waveform in the region of interest. Gate pulse width and the same general shape are thus maintained to avoid saturation and possible time distortion.

Output circuit configuration is similar to that of the horizontal amplifier. Power consumption was reduced from about 10 watts for a conventional Class

A circuit to about 3 watts in this complementary configuration.

Pulse rise time bandwidth of the gate amplifier is about 9 MHz. This matches the internal scope requirements, and the same bandwidth is obtained through the external z-axis input.

FRONT PANEL

The new oscilloscope has a clean, uncluttered appearance. Controls are grouped according to function, Fig. 3. Grouped around the CRT screen on the upper half of the cabinet are the CRT beam controls, power switch, calibrator outputs and horizontal controls. The lower module contains the plug-ins, with the vertical amplifier at the left and the horizontal sweep plug-in at the right. The plug-in release latch is between the two plug-ins. Input jacks are arranged so that cables do not obscure any controls.

By positioning the knob pointers up and centering the lever switches, the scope will be set to a calibrated, normal and automatic state. In other words, a trace will appear which may be adjusted for optimum display of any particular signal.

CONSTRUCTION

When a large volume must be left open for plug-ins, main frame rigidity becomes a problem. In the new scope, the vertical and horizontal plug-ins, whatever their variety, are connected electrically and mechanically before insertion into the main frame. Thus they

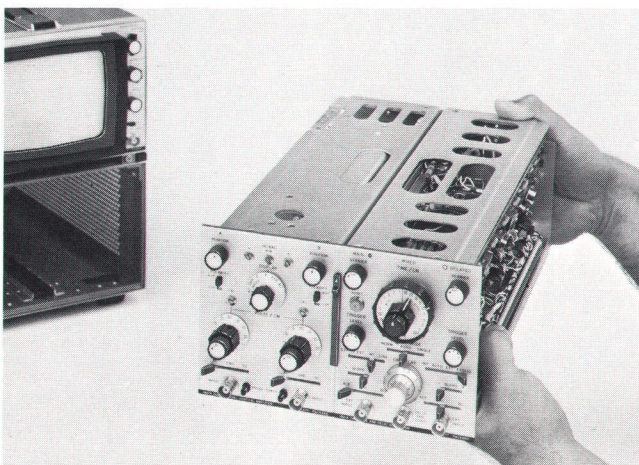
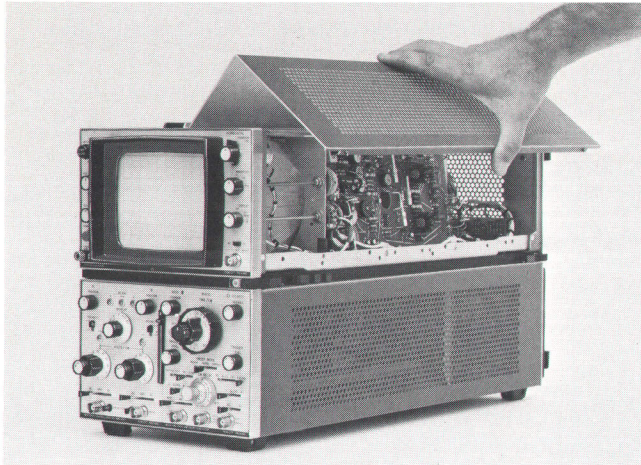

Fig. 13. Plug-ins are connected mechanically and electrically before insertion into the cabinet.



Fig. 14. Latch pulls down making it easy to remove the plug-ins.



(a)

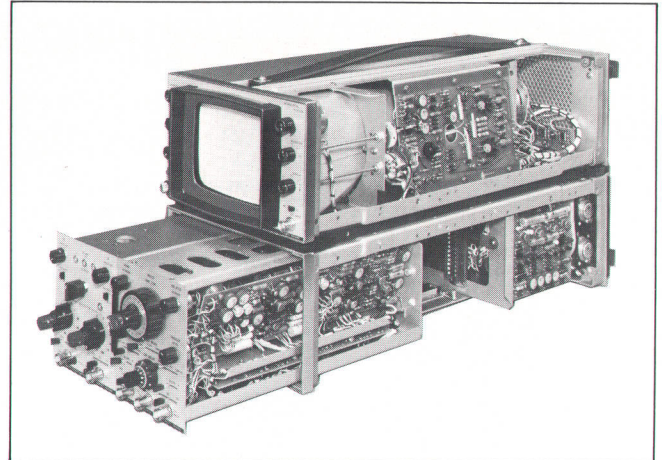

(b)

Fig. 15. All covers easily snap off for servicing, (a). Open frame construction, (b) allows easy servicing

form a single large plug-in which combines with the frame to form a lightweight, rigid structure, Fig. 13. The plug-in sheet metal is the between-circuit shielding. Total weight of the scope with plug-ins is about 30 pounds.

Formerly interconnections between vertical and horizontal plug-ins were made from each plug-in through connectors on the main frame and back to the other plug-in. Direct connection between the plug-ins now reduces distributed capacity and lead inductances. The high frequency triggering problem is minimized because of less capacitive loading on the amplifier output. In this particular case, lead length was reduced by a factor of three.

Vertical CRT deflection is controlled entirely by the left half of the plug-in unit which connects directly to the CRT through its own connector. Therefore, since the interface occurs at the deflection plates, future vertical systems will be limited by the capability of the CRT and not by a main frame amplifier. Sensitivity of the CRT in this oscilloscope is maintained over a bandwidth of higher than 150 MHz.

The two-piece latch between the two plug-in halves unlocks the plug-ins and is used as a handle to remove them. Sliding the upper portion in the direction of the arrow, Fig. 14, releases the lower part which can be pulled down and used to remove the plug-ins.

Power supplies in the main frame supply +100, +15, -12.6 and -100 volts. These voltages are compatible

with transistors and the CRT circuits. The CRT supply is -3000 and +9000 volts.

SERVICE

Open frame construction makes circuits and calibration adjustments easily available for service, Fig. 15. Since

no fan is used, there are no fan filters to change. Natural convection is sufficient to insure stable, accurate operation from -28C to +65C.

The scope will operate in any position. Anti-slip feet are on the bottom, and plastic feet are on the back. Anti-



Fig. 16. New, lightweight scope cart is patterned after a camera tripod and has adjustments for tilt and height.

ELECTRONICALLY-CONTROLLED OSCILLOSCOPE CAMERA

A camera for use with the new -hp- Model 180A Oscilloscope is designed to enable an operator with little or no experience in oscilloscope photography to obtain good oscilloscope photographs without guesswork or trial and error. An all-electronic shutter and a centralized control panel with color-coded controls are designed to eliminate the complexity involved in previous camera systems.

Solid state circuitry and RC timing circuits replace the mechanical devices used for shutter timing in conventional camera shutters. This assures better accuracy at slow shutter speeds which are required for oscilloscope photography. Shutter speeds of this all-electronic camera range from $\frac{1}{30}$ th to 4 seconds. A special high-transmission lens was designed especially for this camera.

The centralized control panel contains all of the necessary controls, and is conveniently placed on the outside of the camera. There are no adjustments inside. The controls include shutter speed, f-stop, and graticule illumination. Terminals for remote operation of the shutter are pro-

vided as well as output terminals from the shutter, which may be used to sync other equipment with the camera.

Color coding of the shutter speed, f-stop and graticule illumination controls give optimum settings for most conditions. Setting the controls to the blue area will result in a good picture for most waveforms, or at least will give a good starting point for further adjustments.

Graticule illumination is controlled by a variable-intensity ultraviolet lamp. This variable-intensity source excites the phosphor on the face of the CRT causing it to glow, making the graticule lines show up black. The result is a picture with a grey background, black graticule lines and white traces whose crossings of the graticule lines can be easily seen.

The ultraviolet lamp can be operated in a 'flash' mode selected by a switch on the panel. When the shutter is operated, the lamp will turn on for 1 second. This feature is useful for recording very slow traces, or for single-sweep traces where the shutter must be open for a long time.

Focus and reduction ratio of the cam-

era are continuously adjustable, permitting optimum use of the camera with different camera backs and with any size graticule. The camera back can be rotated from its normal horizontal to a vertical position so that two smaller photos can be taken on a single film. The back also slides up and down through eleven detented positions.

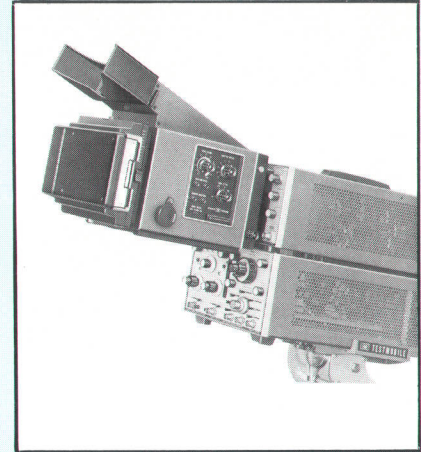

slip feet were not placed on the back so that, when the scope is being used face up, it will slide if bumped rather than tip. These rear feet are high enough so that cables run free underneath.

ACCESSORIES

Adapted from a standard commercial camera tripod, the new scope cart is light and collapsible, Fig. 16.

Viewing hoods are new because of the rectangular CRT design. The oscil-

loscope is designed with an aluminum casting that holds the CRT in from the front. A short, black, molded plastic bezel, or a long, black, molded plastic light shield may be snapped onto the aluminum casting. A rubber viewing hood can be fitted into the long light shield. With the short bezel mounted on the scope, the combination becomes the mounting for the -hp- Model 197A Camera. Adapters

are available for other cameras.

A rack mounting kit is available to convert the -hp- Model 180AR to rack mounting. Height of the rack mounted unit is only $5\frac{1}{4}$ inches. The plug-ins are to the right of the main frame, Fig. 17, and all controls remain accessible from the front.

PROBES

Two new probes were designed for use with the new scope. Standard 10:1

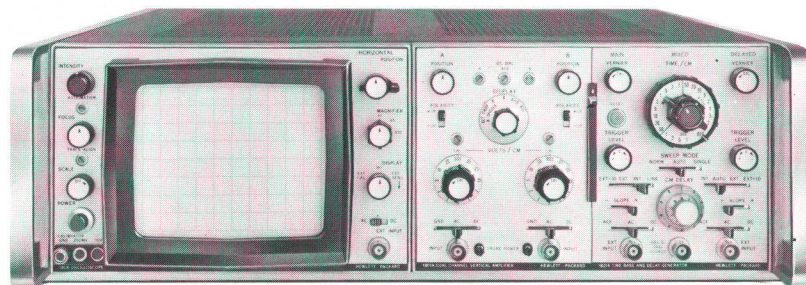

Fig. 17. Rack mounted version of the -hp- Model 180A requires only $5\frac{1}{4}$ inches of rack height.

passive divider probes are smaller and lighter than present probes. Various probe tips are available. Another new probe contains transistors to couple the signal from the tip into the scope. This is a unity gain active probe that improves sensitivity.

ACKNOWLEDGMENT

The *-hp-* Model 180A Oscilloscope was designed by the competent engineering team pictured in the group photo. Electrical design was under the direction of William L. Grein. James D. Williams was in charge of mechanical design. The new short, large screen cathode ray tube was designed under the leadership of Milton E. Russell. W. Mark Wright, Donald Braidwood and Andi Aré were responsible for the design of the *-hp-* Model 197A Oscilloscope Camera.

—Floyd G. Siegel

Manager, High Frequency Oscilloscope Design Section



Included on the project team for the *-hp-* Model 180A are, front row left to right, Andi Aré, Arthur W. Porter, Floyd G. Siegel, William L. Grein, Christian B. Nagel, Johan J. Sverdrup, and Michael D. Johnson. Back row, left to right are William J. Mordan, Robert E. Hobson, Wayne A. Kohl, John D. Cardon, Milton E. Russell, James M. Carner, Daniel C. Paxton, Jr., Donald D. Skarke, and James D. Williams. Not pictured is Jerry L. Boortz.

DESIGN LEADERS



WILLIAM L. GREIN

Bill Grein is group leader on the 180A Oscilloscope system and is responsible for much of the electrical design of the time base and triggering circuitry. Prior to this project he worked on the basic design of the horizontal amplifier, time base and trigger circuits for the *-hp-* Model 175A Oscilloscope. In addition, he designed the 1782A Display Scanner Plug-in for the 175A and the 1471A Time Base and Delay Generator for the *-hp-* Model 140A Oscilloscope. Bill received a BSEE degree from the University of Colorado in 1960 and joined Hewlett-Packard shortly after. He has continued graduate work through the University.

As high frequency engineering section manager, Floyd Siegel has been involved



FLOYD G. SIEGEL

in the development of the 140A, 141A, 191A, and 180A Oscilloscopes. Prior to his appointment as section manager in 1963, he was design leader for the 166D Sweep Delay Generator Plug-in and the 175A Oscilloscope. While a project engineer on the 160B and 170A Oscilloscopes he was granted patents for an off-screen beam locator and a delaying/delayed mixed sweep circuit. Floyd graduated from the University of Utah with a BSEE degree in June, 1957 and started with Hewlett-Packard in July, 1957. He received his MSEE degree from Stanford on the *-hp-* Honors Cooperative Program.

Jim Williams joined Hewlett-Packard



JAMES D. WILLIAMS

at Palo Alto in June, 1956 and worked part-time in the production test area and oscilloscope development lab while attending school. Subsequent to receiving a BSEE degree from San Jose State College he worked on the product design for *-hp-* Models 160B, 170A, and 175A Oscilloscopes and the 1781B Sweep Delay Generator and 1754A Four-Channel Vertical Plug-ins. Jim transferred to the Colorado Springs Division in 1963 where he was responsible for the product design of the 1421A Time Base and Delay Generator Plug-in for the 140A Oscilloscope. Currently he is mechanical design leader for the 180A Oscilloscope system and product design coordinator for the high frequency oscilloscope section.

SPECIFICATIONS

-hp- OSCILLOSCOPE MODEL 180A

180A OSCILLOSCOPE

HORIZONTAL AMPLIFIER:

EXTERNAL INPUT: Bandwidth: DC coupled, dc to 5 MHz; AC coupled, 5 Hz to 5 MHz.

Sensitivity: 1 v/cm, X1; 0.2 v/cm, X5; 0.1 v/cm, X10; vernier provides continuous adjustment between ranges. Dynamic range ± 5 v.

Input RC: 1 megohm shunted by approximately 30 pf.

SWEEP MAGNIFIER: X1, X5, X10; magnified sweep accuracy $\pm 5\%$.

CALIBRATOR:

TYPE: Approximately 1 kHz square wave, 3 μ sec rise time.

VOLTAGE: 2 outputs, 250 mv and 10 v p-p, $\pm 1\%$.

CATHODE-RAY TUBE AND CONTROLS:

TYPE: Post-accelerator tube, 12 kv accelerating potential; aluminized P31 phosphor (P2, P7, and P11 available at no extra charge. Specify by phosphor number).

WRITING RATE: (Using HP 197A Camera with f1.9 lens and Polaroid® 3000 speed film): P31 phosphor, approximately 700 cm/ μ sec.

GRATICULE: 8 x 10 cm parallax-free internal graticule marked in cm squares. 2 mm subdivisions on major axes. Front panel recessed TRACE ALIGN aligns trace with graticule; internal Y-align aligns Y-trace with X-trace. SCALE control illuminates CRT phosphor for viewing with hood or taking photographs.

BEAM FINDER: Pressing Beam Finder control brings trace on CRT screen regardless of setting of horizontal, vertical or intensity controls.

INTENSITY MODULATION: Approximately +2 v, dc to 15 MHz, will blank trace of normal intensity. Input R, 5.1 kohms.

ACTIVE COMPONENTS: All solid state (except CRT).

ENVIRONMENT: 180A Scope with plug-ins operates within specs over the following ranges. Temperature: -28 to +65°C. Humidity: to 95% relative humidity to 40°C. Altitude: to 15,000 feet. Vibration: Vibrated in three planes for 15 min. each with 0.010" excursion from 10 to 55 Hz.

POWER: 115 or 230 v, $\pm 10\%$, 50-1000 Hz, 95 watts at normal line, convection cooled.

DIMENSIONS: Cabinet (overall dimensions with feet, handle): 8" x 11" x 22½" deep. Rack mount: 5¼" x 19" x 19½" deep behind front panel, 21½" deep overall.

WEIGHT (without plug-ins): Model 180A, Net, 22 lbs. (9.9 kg). Shipping, 30 lbs. (13.5 kg). Model 180AR (rack); Net, 25 lbs. (11.3 kg). Shipping, 33 lbs. (14.9 kg).

OUTPUTS: Four emitter follower outputs for main and delayed gates, main and delayed sweeps. Maximum current available, ± 3 ma. Outputs will drive impedances down to 1 kilohm without distortion.

ACCESSORIES FURNISHED: Two Model 10004A 10:1 voltage divider probes, mesh contrast filter, detachable power cord, rack mounting hardware (rack only).

PRICE (without plug-ins): Model 180A, \$825.00; Model 180AR (rack), \$900.00.

1801A DUAL CHANNEL AMPLIFIER

MODES OF OPERATION: Chan. A alone; Chan. B alone; Chan. A and B displayed on alternate sweeps; Chan. A and B displayed by switching at approximately a 400 kHz rate, with blanking during switching; Chan. A plus Chan. B (algebraic addition).

EACH CHANNEL:

DEFLECTION FACTOR (Sensitivity): 0.005 v/cm to 20 v/cm; vernier extends minimum sensitivity to 50 v/cm; a sensitivity calibration adjustment for each channel is provided on the front panel.

ATTENUATOR ACCURACY: $\pm 3\%$.

BANDWIDTH (Direct or with probes. 3 db down from 8 cm 50 kHz reference signal): DC coupled, dc to 50 MHz; AC coupled, 2 Hz to 50 MHz.

RISE TIME (Direct or with probes): Less than 7 nsec. with 8 cm input step.

INPUT RC: 1 megohm shunted by approximately 25 pf.

MAXIMUM INPUT SIGNAL: AC coupled, 600 volts peak; DC coupled, 150 v at 5 mv/cm increasing to 350 v at 20 v/cm.

POLARITY PRESENTATION: + or - Up, selectable.

A + B INPUT:

AMPLIFIER: Bandwidth and sensitivity remain unchanged. Either Channel A or B may be inverted to give A - B operation.

DIFFERENTIAL INPUT (A - B): Common mode rejection at least 40 db at 5 mv/cm, 20 db on other ranges for frequencies up to 1 MHz. Common mode signal should not exceed an amplitude equivalent to 50 cm.

TRIGGERING:

MODE: Chan. A or Chan. B alone, or Chan. A plus Chan. B, on the signal displayed; Chan. A and Chan. B displayed by switching at approximately a 400 kHz rate, on Chan. B alone; Chan. A and B displayed on alternate sweeps, on the signal displayed on each channel or Chan. B alone.

FREQUENCY: Provides sufficient signal to the time base for triggering over the range of dc to 50 MHz with 0.5 cm p-p signal or more displayed on the CRT.

GENERAL:

WEIGHT: Net, 4 lbs. (1.8 kg). Shipping, 6½ lbs. (3 kg).

PRICE: Model 1801A, \$650.00.

1820A TIME BASE

SWEEP RANGE: 24 ranges, 0.05 μ sec/cm to 2 sec/cm in a 1,2,5 sequence; accuracy, $\pm 3\%$; vernier provides continuous adjustment between ranges and extends slowest sweep to at least 5 sec/cm; horizontal magnifier expands fastest sweep to 5 nsec/cm.

TRIGGERING:

INTERNAL: See vertical amplifier plug-in.

EXTERNAL: dc to 50 MHz from signals 0.5 v p-p or more increasing to 1 v at 90 MHz.

AUTOMATIC: Bright base line displayed in absence of input signal. Internal, from 40 Hz, see vertical amplifier specification. External from 40 Hz on signals 0.5 v p-p or more to greater than 50 MHz, increasing to 1 v at 90 MHz.

TRIGGER POINT AND SLOPE: Controls allow selection of level and positive or negative slope; trigger level on external sync signal adjustable over range of ± 5 v, ± 50 v in $\div 10$ position.

COUPLING: AC, DC, ACF; AC attenuates signals below approximately 20 Hz; ACF attenuates signals below approximately 15 kHz.

SINGLE SWEEP: Front panel switch provides single sweep operation.

VARIABLE HOLDOFF: Permits variation of time between sweeps to allow triggering on asymmetrical pulse trains.

WEIGHT: Net, 2¾ lbs. (1.3 kg). Shipping, 5¼ lbs. (2.4 kg).

PRICE: Model 1820A, \$475.00.

1821A TIME BASE AND DELAY GENERATOR

MAIN SWEEP:

RANGE: 22 ranges, 0.1 μ sec/cm to 1 sec/cm in 1,2,5 sequence; accuracy, $\pm 3\%$; vernier provides continuous adjustment between ranges and extends slowest sweep to at least 2.5 sec/cm; horizontal magnifier expands fastest sweep to 10 nsec/cm.

TRIGGERING:

Internal: See vertical amplifier plug-in.

External: dc to 50 MHz from signals 0.5 v p-p or more increasing to 1 v at 90 MHz.

Automatic: Bright base line displayed in absence of an input signal. Internal, from 40 Hz, see vertical amplifier specification. External, from 40 Hz on signals 0.5 v p-p or more to greater than 50 MHz increasing to 1 v at 90 MHz.

Trigger point and slope: Controls allow selection of level and positive and negative slope; trigger level on external sync signal adjustable over range of ± 5 volts, ± 50 v in $\div 10$ position.

Coupling: AC, DC, ACF; AC attenuates signals below approximately 20 Hz; ACF attenuates signals below approximately 15 kHz.

TRACE INTENSIFICATION: Used for setting up delayed or mixed sweep. Increases in brightness that part of main sweep to be expanded full screen in delayed sweep or made magnified part of display in mixed sweep. Rotating Delayed Sweep time switch from OFF position activates intensified mode.

DELAYED SWEEP: Delayed time base sweeps after a time delay set by main sweep and delay controls.

RANGE: 18 ranges, 0.1 μ sec/cm to 50 msec/cm in 1,2,5 sequence; accuracy, $\pm 3\%$; vernier provides continuous adjustment between ranges and extends slowest sweep to at least 125 msec/cm.

TRIGGERING: Applied to intensified Main, Delayed, and Mixed Sweep modes.

Automatic: Delayed sweep starts at end of delayed period.

Internal, External, Slope, Level, and Coupling: Same as Main Sweep triggering.

DELAY (before start of delayed sweep):

Time: Continuously variable from 0.1 μ sec to 10 sec.

Accuracy: $\pm 1\%$; linearity, $\pm 0.2\%$; time jitter is less than 0.005% of maximum delay of each range (1 part in 20,000).

Trigger Output (at end of delay time): approximately 1.5 v with less than 50 nsec rise time from 1 kilohm impedance.

MIXED SWEEP: Dual sweep display in which main sweep drives first portion of display and delayed sweep completes display at speeds up to 1000 times faster.

SINGLE SWEEP: Any display may be operated in Single Sweep.

WEIGHT: Net, 3¾ lbs. (1.7 kg). Shipping, 6¼ lbs. (2.8 kg).

PRICE: Model 1821A, \$800.00.

WORLD-WIDE TIME SYNCHRONIZATION, 1966

Time scales maintained at the world's time-keeping centers have been correlated with new levels of precision in the latest around-the-world flying clock experiment.

WORLD-WIDE SYNCHRONIZATION OF CLOCKS is increasingly important for scientific studies requiring coordinated action at geographically-separated points. For example, precise time synchronization enables better evaluation of the propagation time of radio waves between distant points, leading to a better understanding of ionospheric activity and other factors affecting the propagation of radio waves. Satellite orbital placement and observation of certain astronomical phenomena represent other activities that benefit from precise time synchronization at widely-separated points.

In a continuing effort towards in-

creasing the precision of time scale correlation on a world-wide basis, this year we again carried cesium-controlled clocks to major world time-keeping centers for precision time comparisons.

Two previous time-comparison experiments^{1, 2} established the feasibility of carrying compact cesium-controlled clocks under continuous operation on common conveyances such as commercial aircraft and automobiles. The first of these experiments arose in connection with the 1964 International Con-

¹ Alan S. Bagley and Leonard S. Cutler, 'A New Performance of the Flying Clock Experiment,' *'Hewlett-Packard Journal,'* Vol. 15, No. 11, July, 1964.

² LaThare N. Bodily, 'Correlating Time from Europe to Asia with Flying Clocks,' *'Hewlett-Packard Journal,'* Vol. 16, No. 8, April, 1965.



No matter what the mode of transport, flying clocks were kept in continuous operation throughout entire trip. Clocks were powered by internal batteries when ac line power or auto or airplane electrical power was not available. -hp- engineers Lee Bodily (right) and Ron Hyatt (left) transfer clocks at Geneva airport.



Flying clock (below counter) is compared to NBS frequency and time scales in "clock room" at Boulder Laboratories of National Bureau of Standards. Dr. James Barnes (left), Chief of Atomic Frequency and Time Standards at NBS, and -hp- engineer Lee Bodily discuss techniques of time measurement.

ference on Chronometry in Lausanne, Switzerland. Two portable clock systems, controlled by the newly-developed -hp- Model 5060A Cesium Beam Frequency Standard, were brought to the conference in connection with a paper presented by -hp- engineers Alan Bagley and Leonard Cutler.³ Arrangements were made to correlate the time kept by the clocks with time at the U. S. Naval Observatory. The clocks were subsequently compared with the official Swiss time standard and results were double-checked by a second comparison at the Naval Observatory, on return to the United States, and also at the National Bureau of Standards.

This experiment correlated the Swiss and United States time scales to an accuracy of about 1 microsecond, correlation between the two countries pre-

³ Alan S. Bagley and Leonard S. Cutler "A Modern Solid-State Cesium Beam Frequency Standard" International Conference on Chronometry, June 1964.

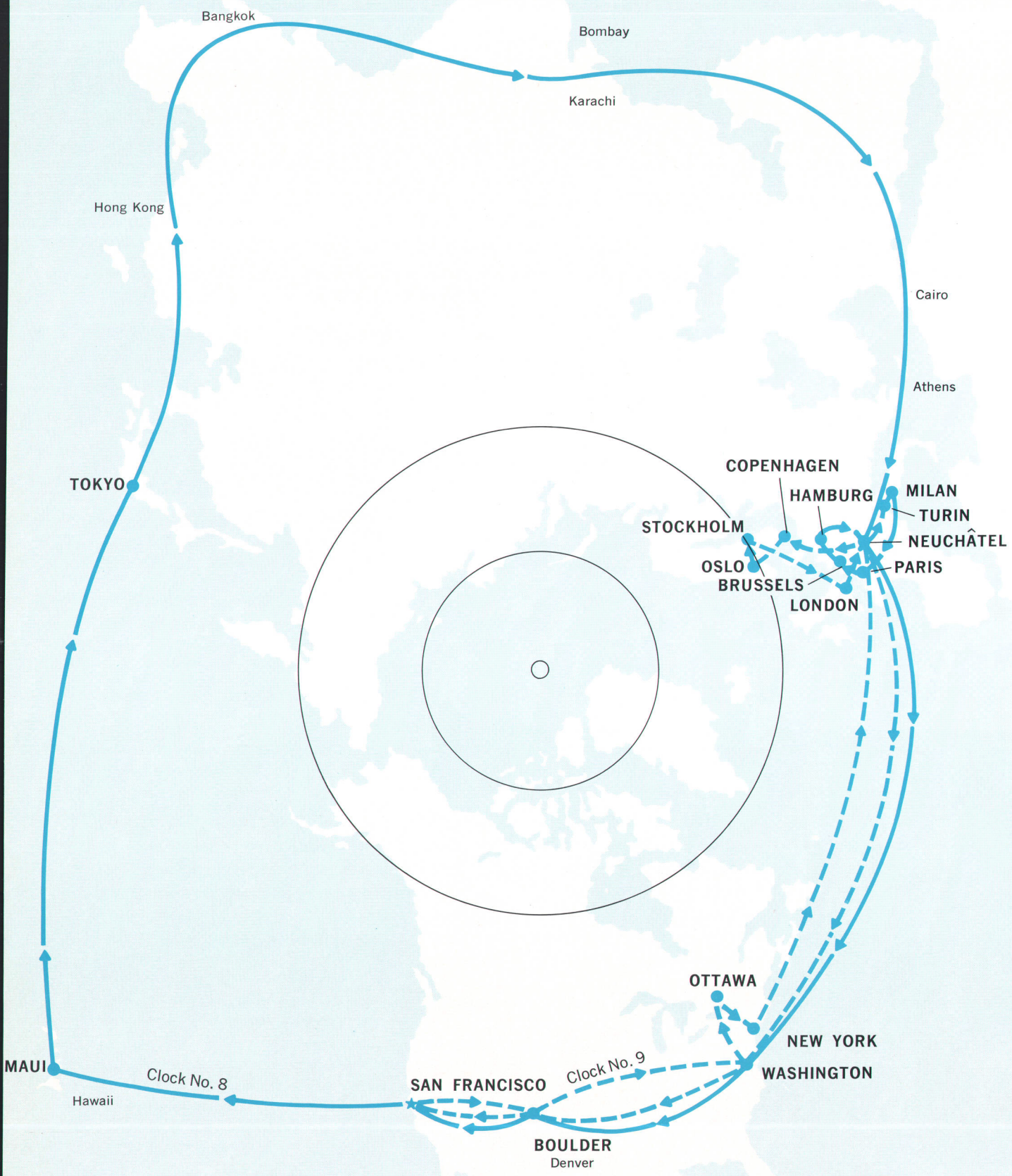

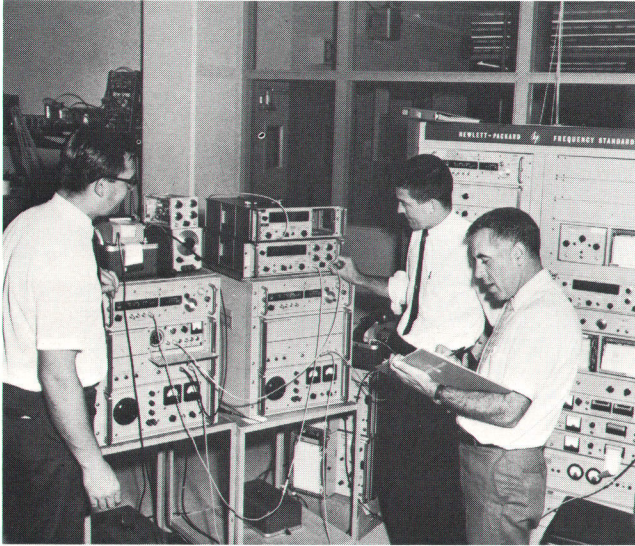

-hp- engineers Lee Bodily, Dexter Hartke, and Ron Hyatt calibrate flying clocks with *-hp-* house standard prior to globe-girdling trip.



Dr. J. Bonanomi (left), Director of the Observatory, Neuchâtel, Switzerland, studies data obtained in time comparisons.

viously being known through high frequency radio signals to a precision of only about 1 millisecond. The experiment also determined the radio propagation time between NBS Standard broadcast station WWV and Switzerland to a tolerance of about 200 microseconds. The measurement was made by comparing the time of arrival of WWV time ticks in Switzerland, as determined by the flying clocks, to the time of transmission as determined by the WWV master clock in Greenbelt, Maryland, which subsequently was compared to the flying clocks. The two portable cesium-beam standards also provided a means for comparing the long-beam cesium standards at the Swiss Laboratory for Horological Research at Neuchâtel and at the National Bureau of Standards at Boulder, Colorado. These measurements showed an agreement between standards within a few parts in 10^{12} .

The high precision of these measurements, coupled with the relative ease with which these clocks can be transported, stimulated requests for similar time and frequency comparisons at several other time-keeping laboratories. Accordingly, a flying clock experiment conducted in 1965 by engineers from the *-hp-* Frequency and Time Division included the major time and frequency standard facilities of Western Europe, Canada, Japan, and the United States,

bringing microsecond precision in time comparisons to all of these facilities. Among other results, the experiment obtained frequency comparisons between all four of the long-beam cesium resonators that serve as national frequency standards in the western world. It also verified the results of a U. S.

Navy time synchronization experiment between California and Japan that used the satellite Relay II, and it repeated the comparison between the U. S. and Swiss time scales. This comparison showed an agreement within 49 microseconds of the previous measurement 273 days earlier. By providing

TABLE I. FACILITIES VISITED DURING 1966 FLYING-CLOCK EXPERIMENT

PLACE	FACILITY
Koganei, Japan	Standard Broadcast Station JJY
Tokyo, Japan	Tokyo Observatory
Maui, Hawaii	Standard Broadcast Station WWVH
Herstmonceux Castle, England	Royal Greenwich Observatory
Teddington, England	National Physical Labs
Bagneux, France	National Center for Communication Studies (CNET)
Paris, France	Paris Observatory
Stockholm, Sweden	Swedish Nat'l Defense Research Institute
Kjeller, Norway	Norwegian Air Force Materiel Command
Copenhagen, Denmark	Royal Danish Air Force Calibration Centre
Hamburg, Germany	German Hydrographic Institute (DHI)
Braunschweig, Germany	National Bureau of Physics and Technology (PTB)
Neuchâtel, Switzerland	Swiss National Observatory
Neuchâtel, Switzerland	Swiss Horological Research Lab
Turin, Italy	National Electrotechnical Institute
Milan, Italy	Astronomical Observatory
Brussels, Belgium	Royal Observatory of Belgium
Brussels, Belgium	University of Brussels
Ottawa, Canada	National Research Council
Ottawa, Canada	Dominion Observatory
Washington, D. C.	U. S. Naval Observatory
Greenbelt, Maryland	U. S. Coast and Geodetic Survey
Greenbelt, Maryland	WWV Transmitter Site
Greenbelt, Maryland	Goddard Space Flight Center (NASA)
Boulder, Colorado	National Bureau of Standards

TABLE II. TIME DIFFERENCES BETWEEN TIME-KEEPING FACILITIES AND ARBITRARILY-SELECTED REFERENCE (-hp- HOUSE STANDARD)

Date	Time (UT)	Facility	Comparison (μ s)*
16 May	1815	NBS-8, Boulder, Colorado	-0.36
16 May	1920	WWVH, Maui, Hawaii	+1.03
17 May	2241	Goddard Space Flt. Cn., Greenbelt, Md.	-29.01
18 May	0945	Radio Res. Lab. (Japan)	+1472.92
18 May	1442	WWV, Greenbelt, Md.	+17.06
18 May	1828	USN Observatory, Wash., D. C.	+77.34
19 May	2015	Nat'l Res. Council (Canada)	+200 487.21‡
20 May	1441	Dominion Obs. (Canada)	+0.08
22 May	1553	HBN time ticks, Neuchatel Obs. (Switzerland)	+884.0
25 May	0737	Royal Danish Air Force	-2370.2
25 May	0716	Inst. Electro Tech. (Italy)	-567.3
25 May	1428	Astro. Observatory (Italy)	-335.0
26 May	0900	Norwegian A.F. Materiel C'm'd.	-90 600.8†
26 May	2050	Swedish Nat'l Def. Lab.	-373.2
27 May	0906	Centre Nat'l d'Et. Tele. (France)	+353.6
31 May	0920	Paris Observatory (France)	+334.8
1 June	1025	Univ. de Bruxelles (Belgium)	+2849.6
1 June	1414	Obs. Royal de Belgique	+408 480.
2 June	0900	Deutsche Hydro. Inst. (Germany)	-36.26
2 June	1040	Nat'l Physics Lab. (England)	+496 939.4†
3 June	0815	Phys.-Tech. Bund. (Germany)	+178.7
3 June	1325	Royal Greenwich Obs. (England)	+58.5
8 June	1329	Swiss Standard Broadcast HBG	+0.02
9 June	1030	Neuchâtel Obs. (Switzerland)	+848.9
13 June	1726	WWV, Greenbelt, Md.	+3.50
13 June	1837	Goddard Space Flt. Cn.	-28.82
14 June	1515	USN Observatory, Wash., D. C.	+75.67
15 June	0155	NBS-8, Boulder, Colorado	-4.93

Results, determined by flying clocks, have been adjusted to account for offset between flying clocks and -hp- House Standard.

* Plus sign means that visited facility is earlier in time than (leads) reference.

‡ 200-ms adjustment not made during past year.

† Operates on atomic time (international second).

time checks between the -hp- house standard and the master clock controlling NBS standard broadcasts, the experiment also confirmed the effectiveness of using VLF standard broadcasts as a means of maintaining accurate time once a time correlation has been established.

FLYING CLOCKS 1966

Continued interest in precise time comparisons provided by the -hp- flying clocks led to a new and more ambitious experiment. This experiment, with higher precision even than before, was performed during the months of May and June of this year. Portable cesium-controlled clocks again were used but with refinements that enabled a potential measurement resolution of 0.02μ s in time comparisons. As a result of the intercomparisons provided by the traveling time standards in the company-funded experiment, many facilities now know with greater precision (about 0.1μ s) how the time of day

at their installations compares with those of other time-keeping centers (see Table II).

The 1966 flying-clock experiment also provided additional data for long-term comparisons between time scales. As shown in Table III, many of the time-keeping centers have maintained time scales, controlled by independent frequency standards, that show a remarkably close correlation with each other.

Among the many other achievements of this year's trip, the flying clocks provided data for use in radio propagation studies being conducted by Mr. Humphry M. Smith of the Royal Greenwich Observatory, England. At his request, time comparisons by the flying clocks were coordinated at several facilities with time comparisons made using time signals from standards broadcast stations.

Another accomplishment of this and previous flying clock experiments was the establishment of an initial 'bench-

TABLE III. TIME SCALE COMPARISONS 1965-1966 REFERENCE: NBS UA

Facility	1965		1966		Change (μ s)
	Date	Time Diff. (μ s) ①	Date	Time Diff. (μ s) ②	
Radio Research Labs	17 Feb	1501	18 May	1474	-27
Nat'l Research Council	11 Mar	506	19 May	489③	-17
U. S. Naval Obs.	13 Mar	158	18 May	79	-79
Neuchâtel Obs. (TUA)	5 Mar	2211④	22 May	2405④	194

① Figures given are adjusted to account for 500μ s retardation of NBS UA on 15 Apr. 66.

② Includes 1.1μ s difference between NBS UA and NBS-8 on 16 May 1966.

③ Adjusted to account for 200 ms retardation of other time scales during period of comparison.

④ Accounts for time difference between Observatory time scale and HBN transmitter ticks.



Dominion Observatory at Ottawa, Canada, is one of major time-keeping centers which compared time with flying clock (below table).

mark' time reference for those facilities that previously have not had access to a precision time reference. As shown by the earlier flying clock experiments, once a time scale has been established in this manner it can be maintained in close agreement with others by continuous comparison of the relative phase of the controlling frequency with respect to a low-frequency standards broadcast.

The experiment was a further demonstration that the portable cesium standards are capable of stable operation in less than ideal environment, being subject to frequent movement and temperature changes as well as being powered from a variety of power sources of questionable stability.

One clock traveled westward from Palo Alto completely around the world and the other traveled eastward to Europe and return. The two clocks were compared prior to departure, again when they met in Switzerland and again on their return to Palo Alto. Over the month-long trip, they accu-

mulated a relative time difference of less than 1 microsecond with respect to each other and with respect to the $-hp$ -house standard. This is believed to be the first time that a system of clocks, two mobile and one stationary, maintained time in mutual agreement to within one microsecond of each other for an entire month of independent operation without resets or frequency adjustments.

The experiment demonstrated another point: cesium-beam frequency standards have an exceptionally high degree of setability. In the 1965 experiment, the cesium-beam standards in two clocks were adjusted independently of one another prior to the experiment, and they subsequently showed an average frequency difference of less than 5 parts in 10^{12} , confirming the accuracy of these instruments as independent primary standards of frequency (specified maximum error is 2 parts in 10^{11}). In the 1966

Long-beam cesium resonator (left rear) at Swiss Laboratory for Horological Research. Dr. Peter Kartaschoff, research physicist in charge of frequency standard development, is in foreground.

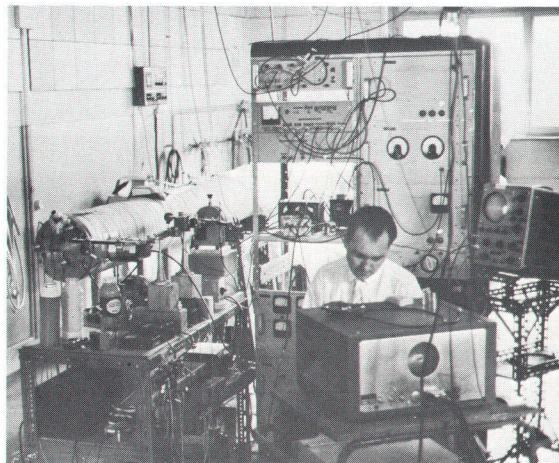

experiment, the 'C' field of each traveling standard was adjusted a calculated amount before departure to adjust the frequency of each closely to the $-hp$ -house standard. Subsequent intercomparisons between the traveling standards and the house standard showed relative frequency differences of less

than 3.6 parts in 10^{13} averaged over 31-day period.

1966 ITINERARY

The 1966 itinerary included most of the time and frequency-standard centers visited in 1965, as well as several that had not been visited on previous

FIRST CESIUM-BEAM RESONATOR

First cesium-beam resonator (left), developed at National Bureau of Standards in Washington, D. C. during 1949–1950 by Dr. Harold Lyons, R. H. McCracken, J. E. Sherwood and others still serves for experimental work on molecular-beam frequency standards at NBS Boulder Laboratories.

(At right) NBS III is third cesium-beam resonator built at NBS (1963). Beam tube (long cylinder at right) has interaction length of 366 cm; ascribed accuracy is ± 6 parts in 10^{12} . NBS III now serves as United States Frequency Standard. Other long beam resonators are now in service at the National Physical Laboratories, England, at the National Research Council, Canada, and at the Swiss Laboratory for Horological Research, Neuchâtel, Switzerland.

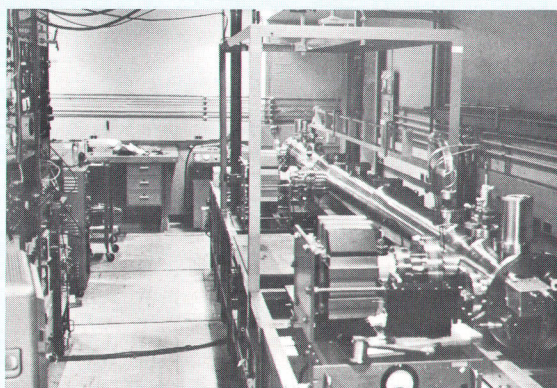
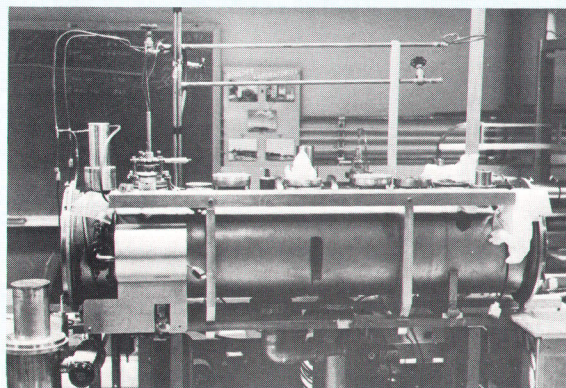

TABLE IV. COMPARISONS BETWEEN FREQUENCY STANDARDS AND FLYING CLOCKS

Date 1966	Local Standard	Type	Time Ref ^a	Comparison Results [†]	Remarks
16 May	NBS III (Boulder)	366 cm Lab Type	A	-299.97 × 10 ⁻¹⁰ , -hp- 9 high	18 samples, 394 seconds each
17 May				-299.99 × 10 ⁻¹⁰ , -hp- 9 high	12 samples
15 June (am)				-299.97 × 10 ⁻¹⁰ , -hp- 9 high	10 samples
15 June (pm)				-299.97 × 10 ⁻¹⁰ , -hp- 9 high	9 samples
15 June (am)				-299.99 × 10 ⁻¹⁰ , -hp- 8 high	14 samples
15 June (pm)	-299.98 × 10 ⁻¹⁰ , -hp- 8 high	8 samples			
19 May	U. S. Naval Observatory	12.4 cm Commercial	UT2	4 × 10 ⁻¹³ , -hp- 9 high	14-hr. phase
15 June				Less than resolution of measurement (-hp- 8 < 10 ⁻¹³)	18-hr. phase
18 May	Goddard Space Flight Center (NASA)	Hydrogen Maser	UT2	4.98 × 10 ⁻¹² , -hp- 9 low; with corrections: -299.960 × 10 ⁻¹⁰ , -hp- 9 high	14-hr. phase
14 June				3.73 × 10 ⁻¹⁰ , -hp- 9 low; with corrections: -299.942 × 10 ⁻¹⁰ , -hp- 9 high	16-hr. phase
19 May	Nat'l Res. Council (Canada)	200 cm Lab Type	A	-300.014 ± 0.007 × 10 ⁻¹⁰ , -hp- 9 low	152 samples, 38 seconds each
19 May	Dominion Observatory (Canada)	12.4 cm Commercial	UT2	1.9 × 10 ⁻¹³ , -hp- 9 high	50 samples, 1000 seconds each
21 May	RRL (Japan)	12.4 cm Commercial	UT2	3.7 × 10 ⁻¹² , -hp- 8 high	24-hr. phase
26 May	Norwegian Air Force	12.4 cm Commercial	A	-299.97 × 10 ⁻¹⁰ , -hp- 9 high	18-hr. phase
27 May	Centre Nat'l d'Etudes Tel. (France)	25 cm Lab Type	UT2	1 × 10 ⁻¹¹ , -hp- low	1-hr. phase
29 May	Swedish Nat'l Def. Res. Lab.	12.4 cm Commercial	UT2	4.1 × 10 ⁻¹² , -hp- 9 high	69-hr. phase
31 May	Observatoire de Paris (France)	25 cm Commercial	UT2	1.7 × 10 ⁻¹¹ , -hp- 8 high	2-hr. phase
2 June	PTB (Germany)	Lab Type	UT2	1.2 × 10 ⁻¹¹ , -hp- 8 low	11-hr. phase
2 June	Nat'l Phys. Lab. (England)	12.4 cm Commercial 277 cm Lab Type	A A	-300.00 × 10 ⁻¹⁰ vs -hp- 9 -300.0 ± 0.1 × 10 ⁻¹⁰	155-min. phase
7 June	Swiss Horological Research Lab.	408 cm Lab Type [‡]	A	-300.026 × 10 ⁻¹⁰ , -hp- 9 low	13 samples, 10 minutes each
8 June				-299.974 × 10 ⁻¹⁰ , -hp- 9 high	16 samples, 10 minutes each
9 June				-299.921 × 10 ⁻¹⁰ , -hp- 9 high	15 samples, 10 minutes each

^a 'A' refers to time scale based on international unit of time (atomic second). Flying clocks operated on UT2 time, offset from atomic second by 300 parts in 10¹⁰.

[†] Frequency offset = (f_t - f_l)/f_l where f_t and f_l are frequencies of traveling and local standards respectively.

[‡] Adjustments were being made to long-beam standard during this time.

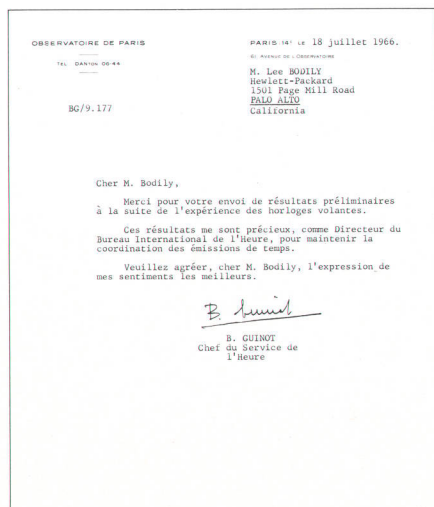

Letter expresses typical response of important timekeeping centers to flying-clock visits. This one, from M. Guinot, Chief of Time Services at Paris Observatory, comments on value of flying-clock visits to him as Director of Bureau International de l'Heure in maintaining coordinated time signal radio transmissions (Bureau International de l'Heure, an international body with headquarters in Paris, annually decides, among other functions, offset from international [atomic] time to be applied to standards radio stations to keep them in close agreement with UT2).

trips. Altogether, 25 facilities in 12 different countries were visited, as listed in Table I. As part of the Royal Greenwich Observatory radio propagation studies, an invitation to visit the facilities of standard radio station OMA in Prague, Czechoslovakia, had been extended to the flying-clock sponsors. Unfortunately, not enough time was available for getting clearance from U. S. authorities, so correlating the time scales of Eastern and Western Europe could not be included in the experiment.

The 1966 experiment started with calibration of the flying clocks to the -hp- house standard in Palo Alto. Two of us (Dexter Hartke and Ronald C. Hyatt) traveled westward with clock no. 8 to WWVH in Hawaii, then to the Tokyo Observatory and the Radio Research Laboratory (Station JJY) in Japan, and then by air westward to a meeting with the third member of our crew (Lee Bodily) and clock no. 9 in Neuchâtel, Switzerland. Clock no. 9, accompanied by Bodily, had come eastward after stops at NBS in Boulder, Colorado, at the Dominion Observa-

tory and the National Research Council in Canada, and at the U. S. Naval Observatory and other facilities in Washington, D. C.

From Neuchâtel, clock no. 8 traveled to facilities in Italy, France, Belgium, and Germany for measurements and then returned to Switzerland. Clock no. 9 made time and frequency comparisons in Switzerland, then went to Denmark, Norway, Sweden, England, and then back to Switzerland for further checks. From there, both clocks returned westward to the United States, with return visits made at the U. S. Naval Observatory, Goddard Space Flight Center, WWV, and the National Bureau of Standards en route to Palo Alto, Calif. These return stops "closed the loop" in the time and frequency comparisons with national standards.

Measurements made on return to Palo Alto showed that clock no. 8 had lost only 0.64 μs with respect to the -hp- house standard, and clock no. 9 had gained 0.28 μs. The less-than-1-μs phase change of the two clocks with respect to each other in 31 days is

equivalent to a frequency offset of less than 3.6 parts in 10^{13} .

EQUIPMENT MODIFICATIONS

Experience gained in previous 'flying clock' experiments pointed the way toward improvements in techniques for the 1966 experiment. For example, the time-interval plug-in for the electronic counter used in time comparisons was modified to obtain a measurement resolution of $0.02 \mu\text{s}$ by multiplying the basic pulse rate of the counter to 50-MHz (the measurement consists of totalizing pulses during the interval between the one-second "ticks" generated by one of the flying clocks and those of the local clock being compared). This high resolution enabled time scale comparisons with precisions of about $0.1 \mu\text{s}$. In addition, new digital clock circuitry, for counting down the output of the cesium-beam frequency standard to the 1-second "ticks," was used. The new circuitry reduced the small amount of phase drift, caused by temperature changes, of the earlier clock frequency dividers—a drift that had not been detectable in the radio

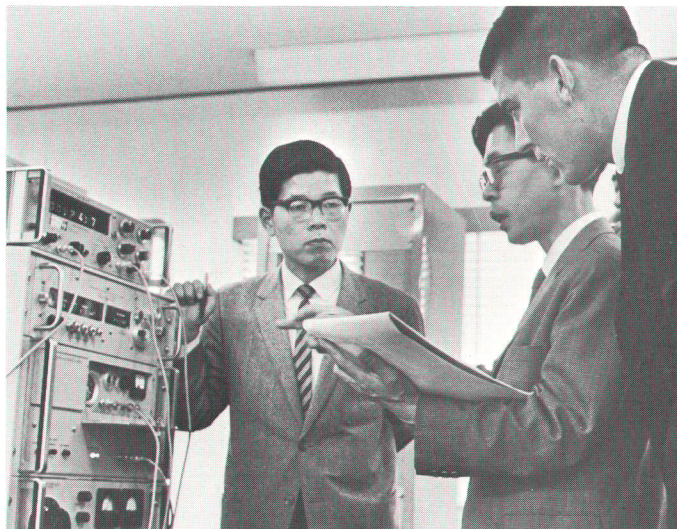

Mr. M. Takemi and Dr. S. Iijima, Acting Director of Time Service, Tokyo Observatory, ponder results of comparison provided by flying clocks.

comparisons for which the clock originally had been designed.

ACKNOWLEDGMENTS

The authors wish to thank the many scientists and engineers, too numerous to mention individually, at the world's

time-keeping and frequency-standards facilities whose eager cooperation made this experiment possible. Of the many impressions we received during the experiments, one of the strongest concerned the dedication of these people who are charged with the responsibil-



LaTHARE N. BODILY

Lee Bodily joined -hp- as a development engineer upon graduation from Utah State University with an EE Degree in 1956. Initially he worked on the 560A Digital Printer, but then was assigned to precision oscillator development, first on the 524 C/D 10-MHz Counter time bases and then as project leader for the 100E, 101A, 106A and 107 Quartz Oscillators and on the 5245L 50-MHz Counter time base. He also contributed to the 103A and 104A Quartz Oscillators and developed the quartz oscillator 'flywheel' for the 5060A Cesium-Beam Frequency Standard. He is now section leader of the Frequency Standards Group with responsibility for both quartz and atomic frequency standard development. Lee earned his MSEE degree at Stanford in

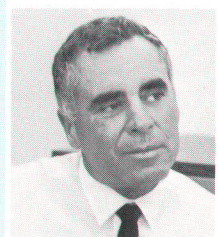

DEXTER HARTKE

the -hp- Honors Cooperative Program and has done further graduate study toward the degree of Electrical Engineer.

Dexter Hartke joined Hewlett-Packard in 1950 following graduation from the University of California (BSEE). Initially he worked on the 512A/B Frequency Converters for the 524A 10-MHz Counter and then on the plug-in versions for the 524 B/C/D Counters and for the 5245L 50-MHz Counter. He also worked on the 524B Counter and was project leader on the 540A/B Transfer Oscillators. Dex has been responsible for both the 113A and 115-A/B/C Frequency Divider and Clocks, the 724A/B and 725B Standby Power Supplies, and the 117A VLF comparators. He continues to work on projects

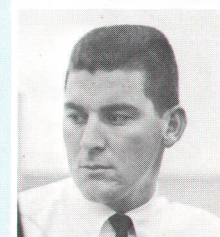

RONALD C. HYATT

related to time measurement.

Ron Hyatt earned his BSEE degree at Texas Technological College and from there he went to Stanford University where he worked as a teaching assistant while earning his Masters degree, which he obtained in 1963. He has also completed course work towards an EE degree. While attending college, Ron did summer work in circuit analysis for an aircraft company.

Ron joined Hewlett-Packard in 1964 and worked on the frequency synthesizer portion of the 5060A Cesium Beam Frequency Standard. He also developed the experimental digital dividers used in this year's flying clock experiment and at present he is working on further cesium-beam frequency standard developments.

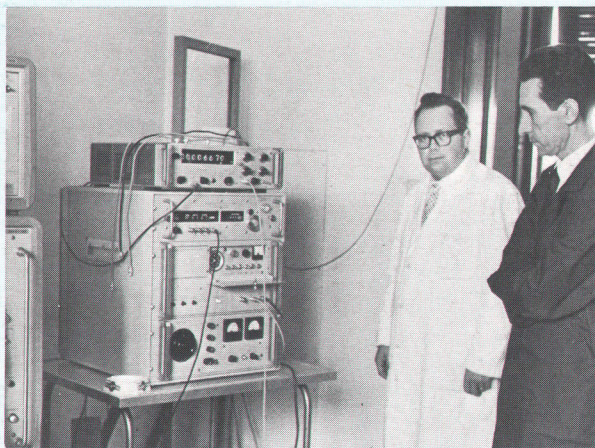

Drs. S. Leschiutta and E. Angelotti of the National Electro Technical Institute, Milan, Italy, study measurement of frequency-comparison between flying clock and Italian national frequency standard.

ity for maintaining national time and frequency standards. They design and construct long-beam cesium standards and other esoteric instrumentation of high precision in spite of the fact that most operate on limited budgets. As was true of the two previous *-hp-* flying clock experiments, all facilities visited were most anxious to be included in the flying-clock itinerary and were most helpful in arranging for the measurements.

*-LaThare N. Bodily,
Dexter Hartke, and
Ronald C. Hyatt*

THE BENCHMARK

Any of several time scales and frequency standards could have been used for the basic reference during the 1966 flying clock experiment. For convenience, the *-hp-* House Standard was chosen but results have shown this standard to be among the most accurate in the world and thus well-suited as a "benchmark" for time and frequency comparisons.

The basic reference within the *-hp-* House Standard is the *-hp-* Model 5060A Cesium Beam Frequency Standard shown here being checked by James Marshall, head of the Radio Frequency Section in the *-hp-* Measurement Standards Lab in Palo Alto, who is responsible for the *-hp-* House Standard. The output of the Cesium Beam Standard is compared in phase continuously against NBS Standards Stations WWVB and WWVL by the VLF Comparators at lower right. Continuous comparison since this Cesium Beam Standard was put into service last January enables its relationship to the United States Frequency Standard to be known within parts in 10^{12} . The standard is also compared to two of the Navy VLF stations by the VLF receivers, shown to the left of the main rack.

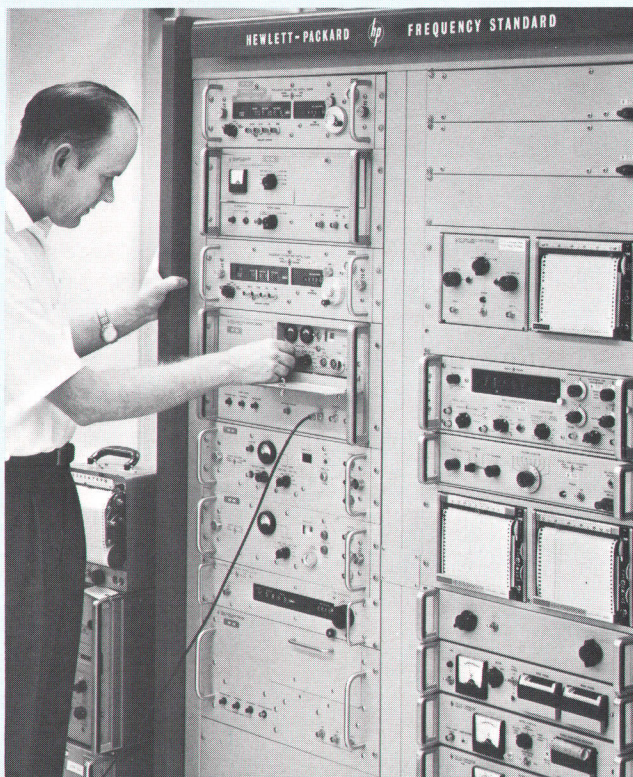

The clock mechanism immediately above the Cesium Standard integrates the Cesium Standard output to show any accumulated phase error.

The house working frequency standard is the *-hp-* Model 107A Quartz Oscillator, immediately below the Cesium Beam Standard. This oscillator has the high short-term stability desired for a working standard and since it has been in continuous operation for three

years, it has aged to the point that its drift rate is only 1×10^{-11} per day. The phases of the Quartz and Cesium Beam Standards are compared continuously by the instruments at right upper and corrections are made daily to the Quartz Standard to maintain it within 5 parts in 10^{12} of the Cesium Standard during working hours. The output of the quartz oscillator is distributed throughout the *-hp-* plant in Palo Alto.

The *-hp-* working time standard is the *-hp-* Model 106A Quartz Oscillator and the Digital Clock above the Cesium Standard. Separation of the working time and frequency standards allows corrections to be made to the working frequency standard without accounting for accumulated phase error. The working time standard is maintained within a few μs of the NBS UA time scale by continuous comparisons of the Quartz Oscillator frequency against WWVB and WWVL and against the Cesium Beam Standard. The NBS UA time scale is a variable time scale offset from NBS A (an atomic time scale based on the U. S. Frequency Standard) by the currently accepted value published by the Bureau International de l'Heure.

A standby quartz oscillator and a standby cesium-beam standard (a prototype unit), below the working quartz standard, prevent loss of either time or phase information should any of the primary units drop out of service (all units are fail-safe in that any transient condition that could cause a jump in phase or time immediately shuts down the unit affected). All frequency standards and oscillators are operated from standby power supplies which provide battery power to assure continuity of operation in the event that ac line power is interrupted.